

DRIVEN TOOLING

For

STAR



10139 BERGIN RD.

HOWELL, MI 48843

PHONE : 877-91-TOOLS (810-632-4446)

FAX: 877-92-TOOLS (810-632-4467)

EMAIL: info@mdtooling.com

WEBSITE: www.mdtooling.com

Live Tooling



M. T. Marchetti, a major live tool manufacturer in northern Italy, is a leader in live tool technology. The formula is simple. Use only the best angular contact high-speed bearings available. Add to this an exacting tolerances for all ground shafts, gears and bearing pocket features. Next, develop a sealed system that **will not** allow any contamination from chips or coolant.

Top this all off with a superior design and you end up with a live tool that is more rigid, faster and will last longer. **We back this up with a 2-Year factory warranty.**

Our Live Tool Warranty

Our tooling will give years of service in the most demanding applications. The superior design and rugged construction has proven this over the last 12 years. The reliability of our tools allows us to provide a 2-year factory warranty, for non-wear components.

MD Tooling will repair any defective tool holders for a period of 2 years from the date of purchase.

Product Range

We have the largest range of live tooling available for most major machine tool manufactures.

Our available products include an extensive line of standard live tooling as well as specialty tool holders such as 0-180 adjustable angle tool holders, gear hobbors, and even worm gear generators. Our product range includes geared up holders to 60,000 RPM and are engineered for 1,000 PSI coolant through.

We are an industry leader in providing complete tooling solutions with hundreds of static tool options as well.

Technical Support

Here at MD Tooling we have a full technical support department with over 35 years of CNC experience.

Our highly qualified staff can help with part processing, tooling up a job from a blue print and even assist with part programming. Applications Engineers are always available by phone to answer any questions you may have about our tooling or any other CNC related issue.

Stock and Replenishment

MD Tooling maintains an extensive inventory of tooling in our warehouse in Michigan. Our current "fill" rate on orders is 93% from our stock in Michigan for same day shipping.

Should you require a non-stock item, our manufacturer, M.T. Marchetti also maintains a large inventory in Italy. Tooling can be obtained in as little as 3-5 business days.

Shipping

MD Tooling realizes that when you need tooling, often you can't wait until the next day. We process orders and ship from available stock right up until 4PM EST to make certain we get your tooling solutions to you as quickly as possible.

We regularly ship throughout the day via UPS, FedEx or any other carrier that a customer requests.



10139 Bergin Road
Howell, MI 48843
Phone: (810) 632-4446
Fax: (810) 632-4467
Email: info@mdtooling.com
Web: www.mdtooling.com

- Fast, Friendly, Reliable Service!
- Quality tooling at highly competitive pricing.
- 2-Year Warranty on all live tools.
- Extensive inventory. We currently ship over 93% of all orders same day.
- In-house repair services available.
- If a warranty tool needs to be returned for inspection, service or repair, loaner tools are available to keep your machine tool production up and running.
- More specialty tool holders than any other manufacturer.
- Custom tool holders available.
- All available tooling may not be shown in this catalog. If you can't find the holder you're looking for, please contact our office for assistance.



Table of Contents

Categorized Listing

ECAS12/20 - SB12/16/20 - SR10J - SR16/20	1
SR20/32JIIB - SR32J/JN - SV12/20 - SV20R - SW12RII	1
DRIVEN	1
AXIAL DRIVEN TOOL	1
ECAS12/20 - SB12/16/20 - SR16/20 - SR20RIV	1
SR20/32JIIB - SR32J/JN	1
DRIVEN	1
RADIAL REAR-SET DRIVEN TOOL	1
ECAS12/20 - ECAS32T - SB12/16/20 - SR16/20	2
SR20RIV - SR20/32JIIB - SR32J/JN - SV12/20 - SV32 - SV32JII - SV38R - SW20	2
DRIVEN	2
AXIAL DRIVEN TOOL	2
ECAS12/20 - SB12/16/20 - SR16/20 - SR20RIV	2
SR20/32JIIB - SR32J/JN	2
DRIVEN	2
RADIAL REAR-SET DRIVEN TOOL	2
ECAS32T - ST38 - SV32 - SV38R (10ST. TURRET)	3
DRIVEN	3
RADIAL DRIVEN TOOL	3
ECAS32T - ST38 - SV38R (10ST. TURRET)	3
DRIVEN	3
AXIAL REAR-SET DRIVEN TOOL	3

ECAS12/20 - SB12/16/20 - SR10J - SR16/20 - SR20/32JIIB - SR32J/JN - SV12/20 - SV20R - SW12RII

DRIVEN

AXIAL DRIVEN TOOL

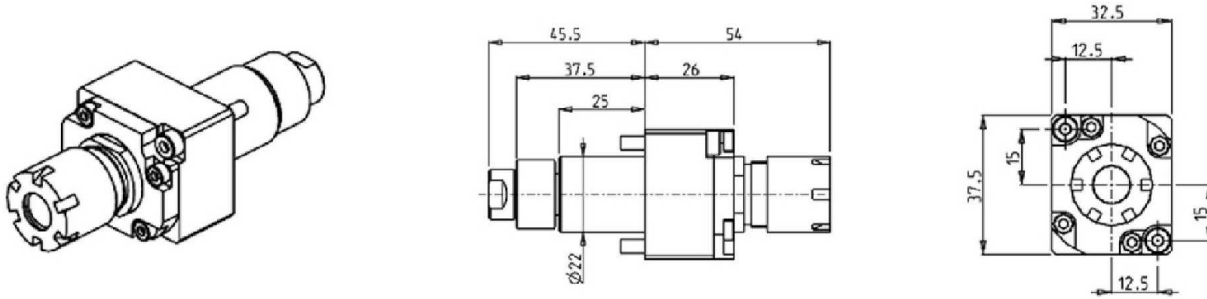

Part Number	Description	Spindle	I	RPM	Ext Cool
STR0020116	Axial Driven Tool ER16	ER16	1:1	8000	X

ECAS12/20 - SB12/16/20 - SR16/20 - SR20RIV - SR20/32JIIB - SR32J/JN

DRIVEN

RADIAL REAR-SET DRIVEN TOOL

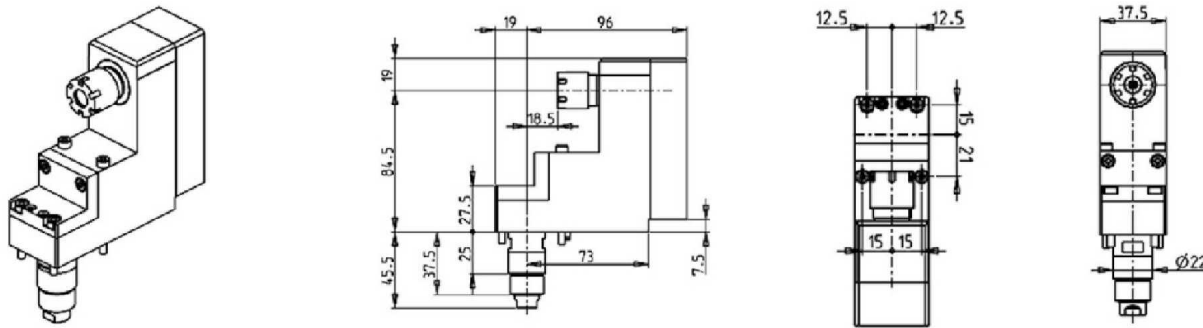

Part Number	Description	Spindle	I	RPM	Ext Cool
STR0030116	Radial Rear-Set Driven Tool ER16	ER16	1:1	8000	X

ECAS12/20 - ECAS32T - SB12/16/20 - SR16/20 - SR20RIV - SR20/32JIIB - SR32J/JN - SV12/20 - SV32 - SV32JII - SV38R - SW20

DRIVEN

AXIAL DRIVEN TOOL

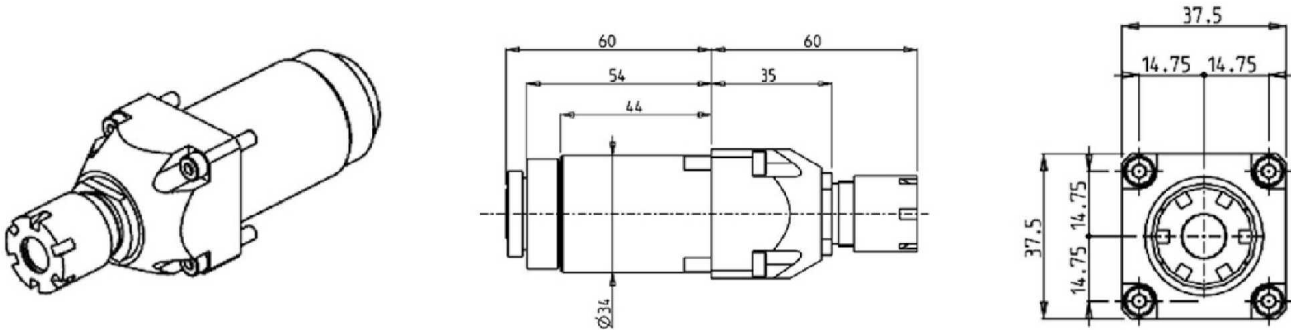

Part Number	Description	Spindle	I	RPM	Ext Cool
STR0040116	Axial Driven Tool ER16	ER16	1:1	8000	X

ECAS12/20 - SB12/16/20 - SR16/20 - SR20RIV - SR20/32JIIB - SR32J/JN

DRIVEN

RADIAL REAR-SET DRIVEN TOOL

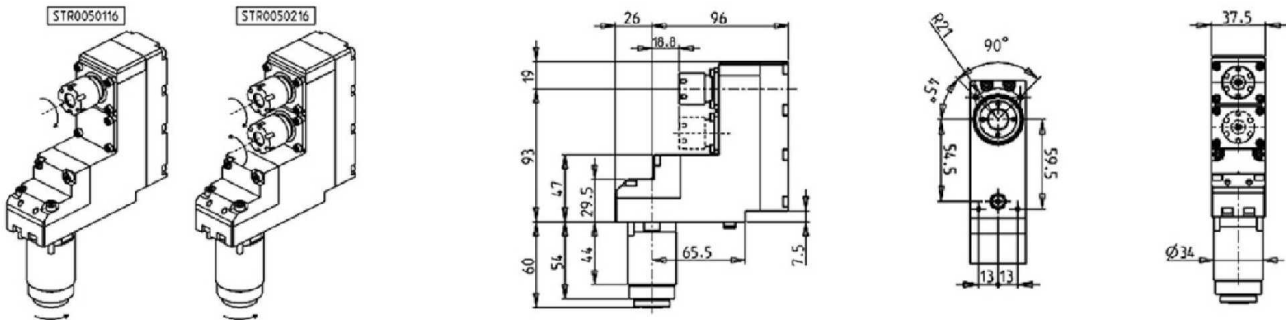

Part Number	Description	Spindle	I	RPM	Ext Cool
STR0050116	Radial Rear-Set Driven Tool ER16	ER16	1:1	8000	X
STR0050216	Radial Rear-Set Driven Tool ER16+ER16	ER16+ER16	1:1	8000	X

ECAS32T - ST38 - SV32 - SV38R (10ST. TURRET)

DRIVEN

RADIAL DRIVEN TOOL

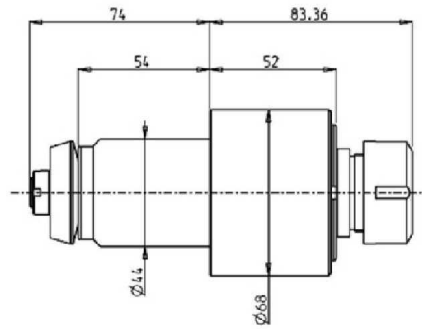
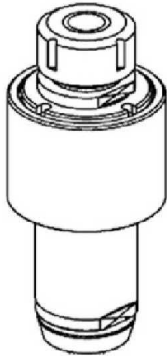

Part Number	Description	Spindle	I	RPM	Ext Cool
STR0010125	Radial Driven Tool ER25	ER25	1:1	6000	X

ECAS32T - ST38 - SV38R (10ST. TURRET)

DRIVEN

AXIAL REAR-SET DRIVEN TOOL

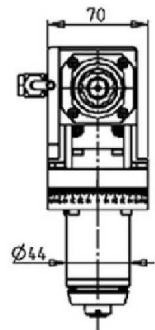
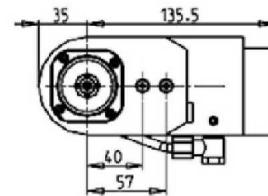
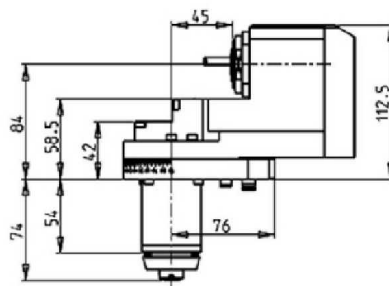
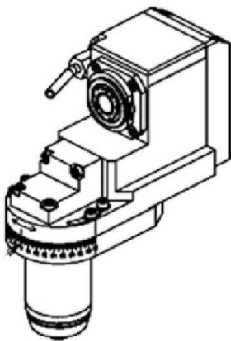

Part Number	Description	Spindle	I	RPM	Cool Thru	Ext Cool
STR0060320	Axial Rear-Set Driven Tool ERA20	ERA20	1:1	6000		X
STR0060420	Axial Rear-Set Driven Tool ERA20 Cool Thru*	ERA20	1:1	6000	X	X

* Coolant Thru tools are designed for 1000 psi.
They require 5 Micron Filtration and **CANNOT** be run dry.

ER COLLETS

ER COLLET NUMBER	DESCRIPTION	MD LIST PRICE
ER20 SET	ER20 Collet Set (15 Collets)	\$ 330.00
ERX20 SET	ER20 Sealed Collet Set (13 Collets)	\$ 395.00
ER25 SET	ER25 Collet Set (19 Collets)	\$ 375.00
ERX25 SET	ER25 Sealed Collet Set (17 Collets)	\$ 475.00
ER32 SET	ER32 Collet Set (21 Collets)	\$ 425.00
ERX32 SET	ER32 Sealed Collet Set (21 Collets)	\$ 595.00
ER40 SET	ER40 Collet Set (29 Collets)	\$ 695.00
ERX40 SET	ER40 Sealed Collet Set (27 Collets)	\$ 850.00



Phone: (810) 632-4446 / Fax: (810) 632-4467

Table of Contents

Alphabetized Listing

A

AXIAL DRIVEN TOOL	1-2
AXIAL REAR-SET DRIVEN TOOL	3

D

DRIVEN	1-3
--------	-----

E

ECAS12/20 - ECAS32T - SB12/16/20 - SR16/20 - SR20RIV SR20/32JIIB - SR32J/JN - SV12/20 - SV32 - SV32JII - SV38R - SW20	2
ECAS12/20 - SB12/16/20 - SR10J - SR16/20 - SR20/32JIIB SR32J/JN - SV12/20 - SV20R - SW12RII	1
ECAS12/20 - SB12/16/20 - SR16/20 - SR20RIV - SR20/32JIIB SR32J/JN	1-2
ECAS32T - ST38 - SV32 - SV38R (10ST. TURRET)	3
ECAS32T - ST38 - SV38R (10ST. TURRET)	3

R

RADIAL DRIVEN TOOL	3
RADIAL REAR-SET DRIVEN TOOL	2
RADIAL REAR-SET DRIVEN TOOL	1

Table of Contents

Part Number Index

S

STR0010125	Radial Driven Tool ER25	3
STR0020116	Axial Driven Tool ER16	1
STR0030116	Radial Rear-Set Driven Tool ER16	1
STR0040116	Axial Driven Tool ER16	2
STR0050116	Radial Rear-Set Driven Tool ER16	2
STR0050216	Radial Rear-Set Driven Tool ER16+ER16	2
STR0060320	Axial Rear-Set Driven Tool ERA20	3
STR0060420	Axial Rear-Set Driven Tool ERA20 Cool Thru*	3